

Data Sheet



Article number: 07110403001

Description: Universal joint single 0.110.403.001
S=180 X= Bore 40 H7 with keyway

Measures

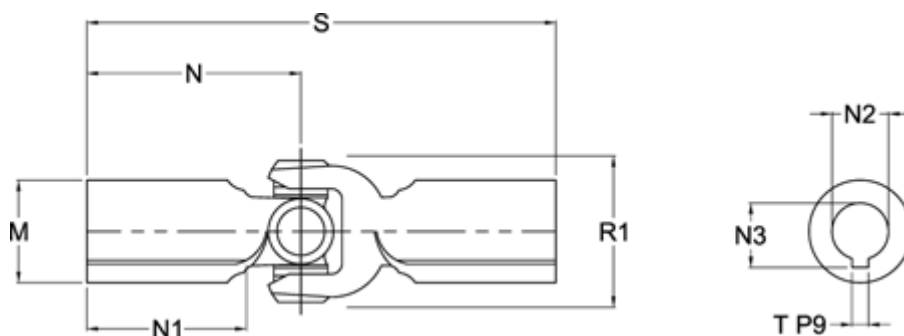

M	= 62	T = 12 P9
Max. Bending Angle degrees	= 20	
N	= 90	
N1	= 58	
N2	= 40 H7	
N3	= 43,3 +0,2	
R1	= 98	
S min	= 180	